



TO-252-2L Plastic-Encapsulate Diode

SBDD1045CT SCHOTTKY BARRIER RECTIFIER

MAIN CHARACTERISTICS

I_o	10 (2x5) A
V_{RRM}	45 V
T_j	150 °C
$V_{F(typ)}$	0.48V (@$T_j=125^{\circ}C$)

FEATURES

- Low Power Loss, High Efficiency
- Guard Ring Die Construction for Transient Protection
- High Current Capability and Low Forward Voltage Drop

MARKING

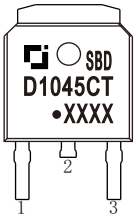

SBDD1045CT= Device code
 Solid dot = Green molding compound device,
 if none, the normal device
 XXXX= Code

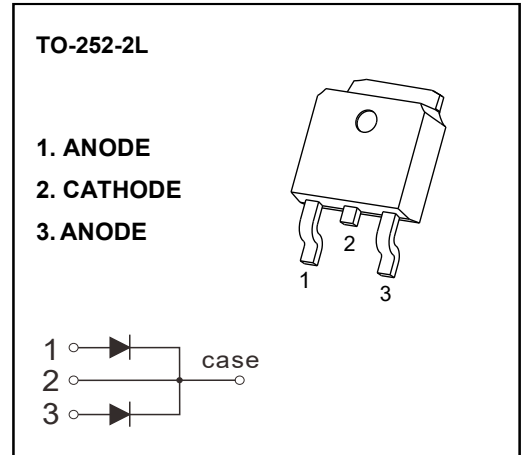

MAXIMUM RATINGS ($T_c=25^{\circ}C$ unless otherwise noted)

Symbol	Parameter	Value	Unit
V_{RRM}	Peak repetitive reverse voltage	45	V
V_{RWM}	Working peak reverse voltage		
V_R	DC blocking voltage		
$V_{R(RMS)}$	RMS reverse voltage	31.5	V
I_o	Average rectified output current	10	A
I_{FSM}	Non-Repetitive peak forward surge current (8.3ms half sine wave)	120	A
$R_{\theta JC}$	Thermal resistance from junction to case	5.0	$^{\circ}C/W$
$R_{\theta JA}$	Thermal resistance from junction to ambient	100	$^{\circ}C/W$
T_j	Junction temperature	150	$^{\circ}C$
T_{stg}	Storage temperature	-55~+150	$^{\circ}C$

ELECTRICAL CHARACTERISTICS ($T_c=25^{\circ}C$ unless otherwise specified)

Parameter	Symbol	Test conditions	Min	Typ	Max	Unit
Reverse voltage	$V_{(BR)}$	$I_R=0.1mA$	45			V
Reverse current	I_R	$V_R=45V$	$T_j = 25^{\circ}C$	20	100	μA
			$T_j = 125^{\circ}C$	20		mA
Forward voltage	V_F	$I_F=3A$	$T_j = 25^{\circ}C$	0.46		V
			$T_j = 125^{\circ}C$	0.40		V
		$I_F=5A$	$T_j = 25^{\circ}C$	0.52	0.60	V
			$T_j = 125^{\circ}C$	0.48		V

*Pulse test: pulse width $\leq 300\mu s$, duty cycles $\leq 2.0\%$.

Typical Characteristics

FIG.1: FORWARD CURRENT DERATING CURVE

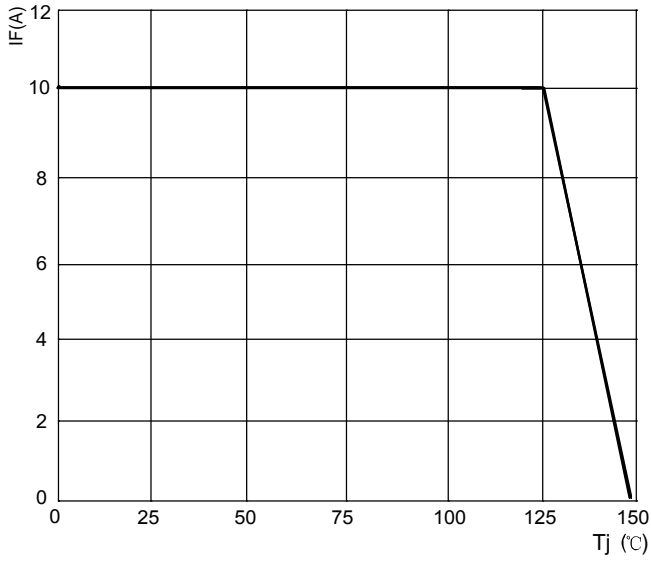

FIG.2: TYPICAL FORWARD CHARACTERISTICS

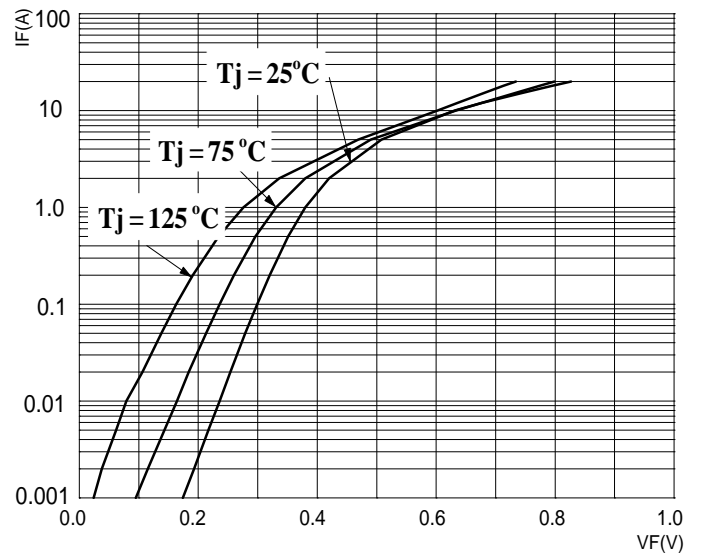

FIG.3: TOTAL CAPACITANCE DERATING CURVE

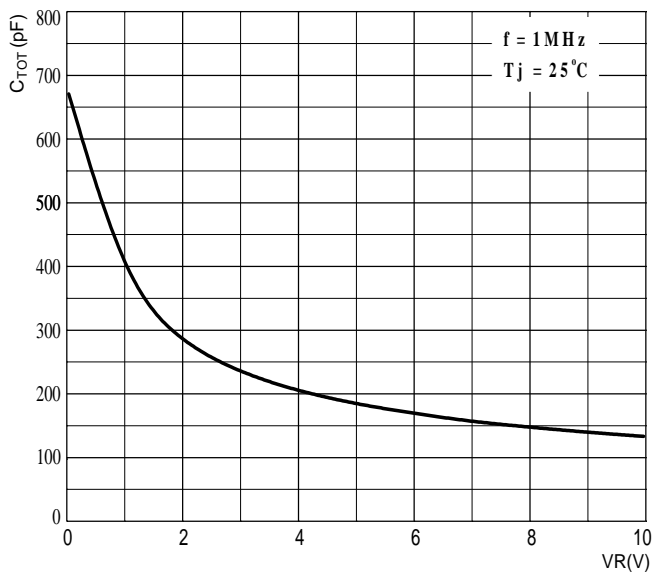
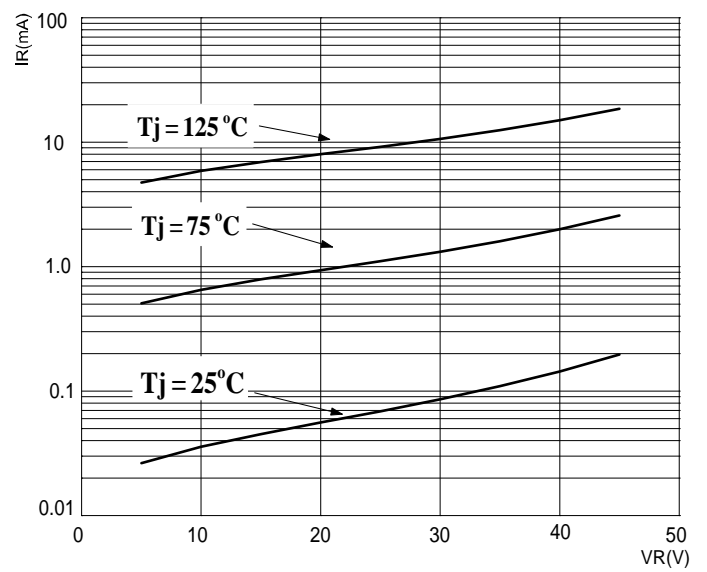
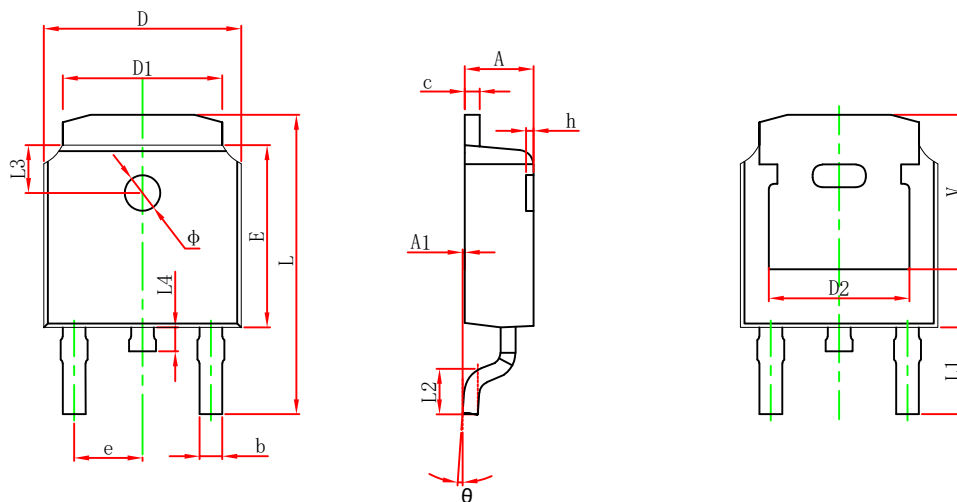

FIG.4: TYPICAL REVERSE CHARACTERISTICS



TO-252-2L Package Outline Dimensions



Symbol	Dimensions In Millimeters		Dimensions In Inches	
	Min.	Max.	Min.	Max.
A	2.200	2.400	0.087	0.094
A1	0.000	0.127	0.000	0.005
b	0.635	0.770	0.025	0.030
c	0.460	0.580	0.018	0.023
D	6.500	6.700	0.256	0.264
D1	5.100	5.460	0.201	0.215
D2	4.830 REF.		0.190 REF.	
E	6.000	6.200	0.236	0.244
e	2.186	2.386	0.086	0.094
L	9.712	10.312	0.382	0.406
L1	2.900 REF.		0.114 REF.	
L2	1.400	1.700	0.055	0.067
L3	1.600 REF.		0.063 REF.	
L4	0.600	1.000	0.024	0.039
Φ	1.100	1.300	0.043	0.051
θ	0°	8°	0°	8°
h	0.000	0.300	0.000	0.012
V	5.250 REF.		0.207 REF.	

TO-252-2L Suggested Pad Layout

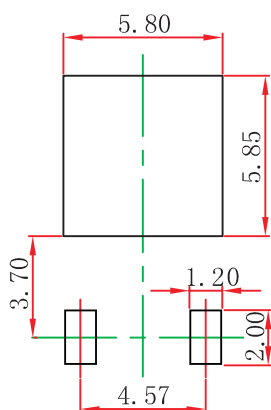

- Note:
1. Controlling dimension: in millimeters.
 2. General tolerance: ± 0.05 mm.
 3. The pad layout is for reference purposes only.

TO-252-2L Tape and Reel

TO-252 Embossed Carrier Tape

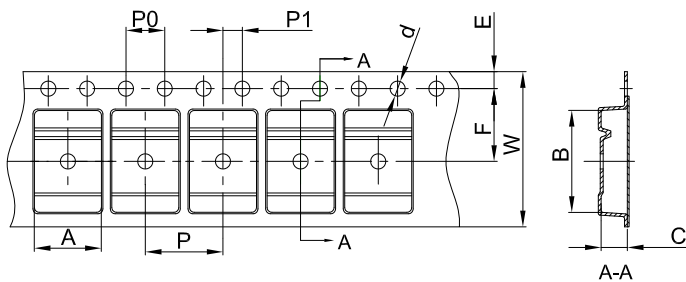

Packaging Description:

TO-252 parts are shipped in tape. The carrier tape is made from a dissipative (carbon filled) polycarbonate resin. The cover tape is a multilayer film (Heat Activated Adhesive in nature) primarily composed of polyester film, adhesive layer, sealant, and anti-static sprayed agent. These reeled parts in standard option are shipped with 25,00 units per 13" or 33.0 cm diameter reel. The reels are clear in color and is made of polystyrene plastic (anti-static coated).

Dimensions are in millimeter										
Pkg type	A	B	C	d	E	F	P0	P	P1	W
TO-252	6.90	10.50	2.70	Ø1.55	1.75	7.50	4.00	8.00	2.00	16.00

TO-252 Tape Leader and Trailer

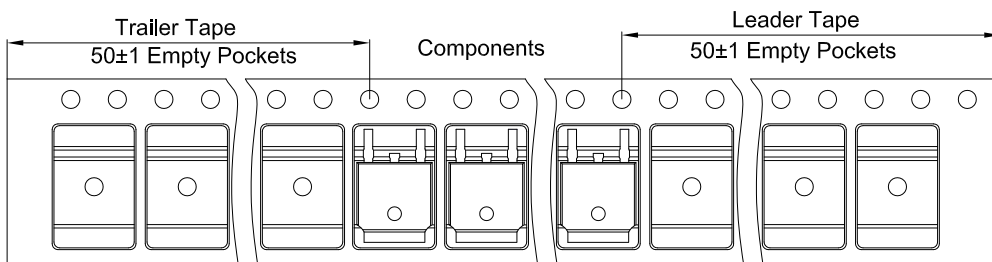

TO-252 Reel

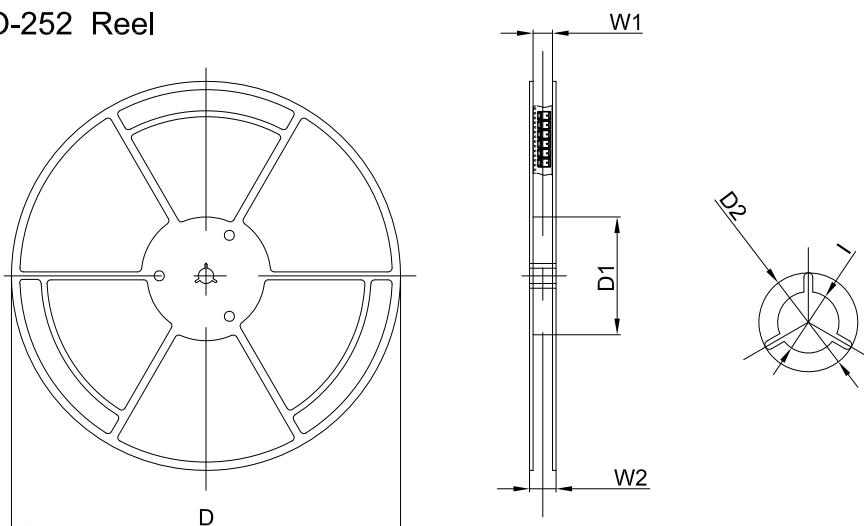

Dimensions are in millimeter						
Reel Option	D	D1	D2	W1	W2	I
13" Dia	330.00	100.00	Ø21.00	16.40	21.00	Ø13.00

REEL	Reel Size	Box	Box Size(mm)	Carton	Carton Size(mm)	G.W.(kg)
2,500 pcs	13inch	2,500 pcs	340×336×29	25,000 pcs	353×346×365	