



## SOT-353 Plastic-Encapsulate Diodes

### DA227 SWITCHING DIODE

#### FEATURES

- High speed
- Suitable for high packing density layout
- High reliability

#### MARKING: N20



Solid dot = Green molding compound device.

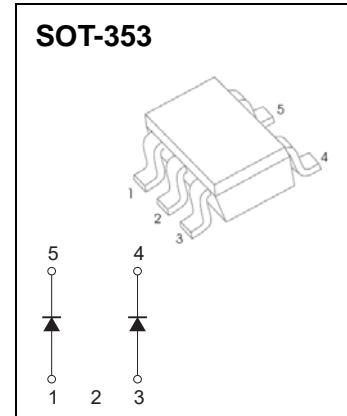

#### Maximum Ratings @Ta=25°C

Parameter	Symbol	Limit	Unit
Non-Repetitive Peak Reverse Voltage	$V_{RM}$	80	V
DC Blocking Voltage	$V_R$	80	V
Forward Continuous Current	$I_{FM}$	300	mA
Non-Repetitive Peak Forward Surge Current @t=8.3ms	$I_{FSM}$	2.0	A
Average Rectified Output Current	$I_O$	100	mA
Power Dissipation	$P_D$	200	mW
Thermal resistance From Junction to ambient	$R_{\theta JA}$	625	°C/W
Operation Junction and Storage Temperature Range	$T_J, T_{STG}$	-55~+150	°C

#### ELECTRICAL CHARACTERISTICS (Ta=25°C unless otherwise specified)

Parameter	Symbol	Test conditions	Min	Max	Unit
Reverse breakdown voltage	$V_{(BR)}$	$I_R=100\mu A$	80		V
Reverse voltage leakage current	$I_R$	$V_R=70V$		0.1	$\mu A$
Forward voltage	$V_F$	$I_F=100mA$		1.2	V
Diode capacitance	$C_D$	$V_R=6V, f=1MHz$		3.5	pF
Reverse recovery time	$t_{rr}$	$V_R=6V, I_F=5mA$		4	ns

# Typical Characteristics

**Forward Characteristics**

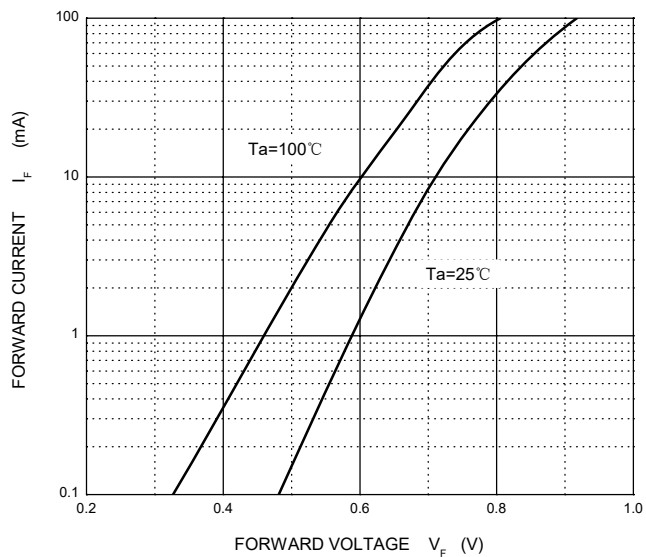

**Reverse Characteristics**

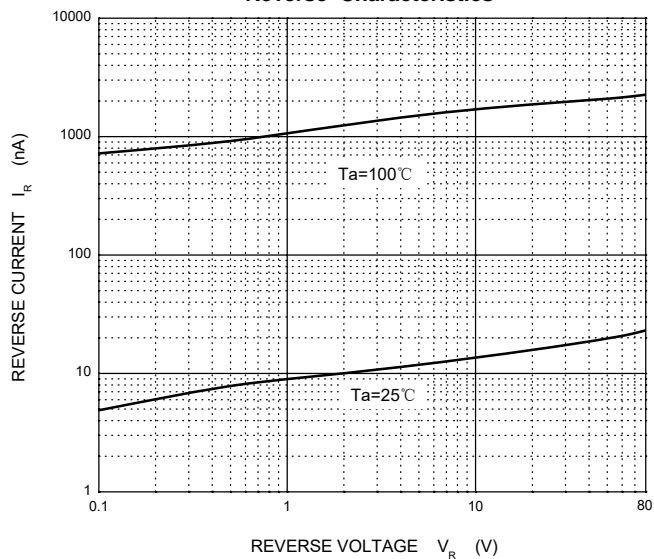

**Capacitance Characteristics**

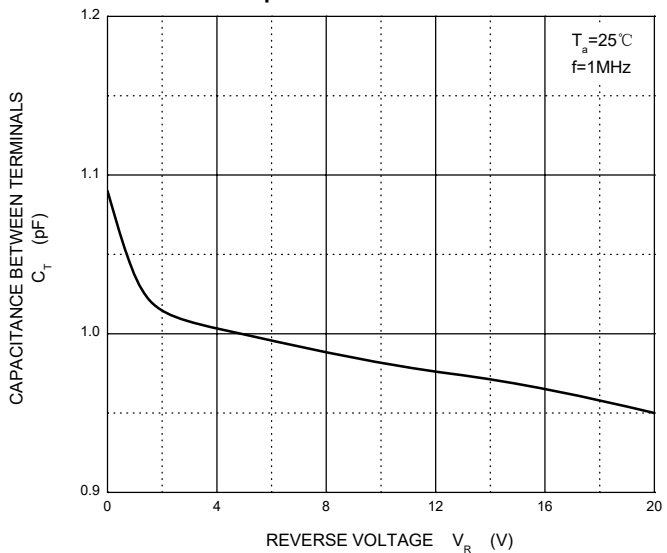

**Power Derating Curve**

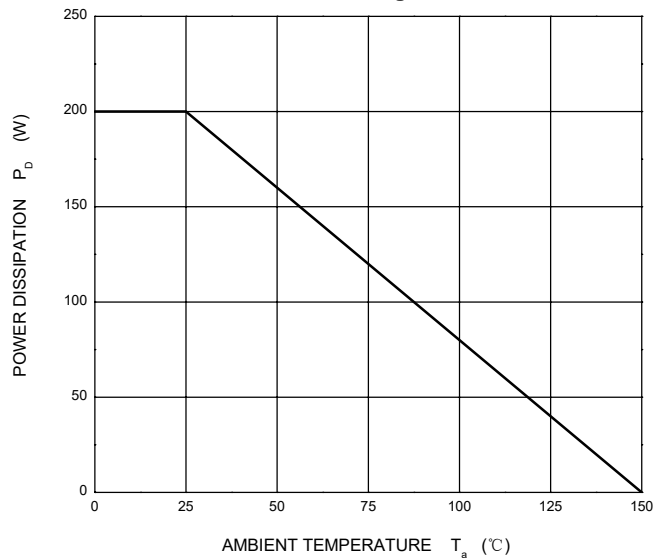

## SOT-353 Package Outline Dimensions

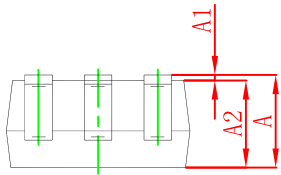
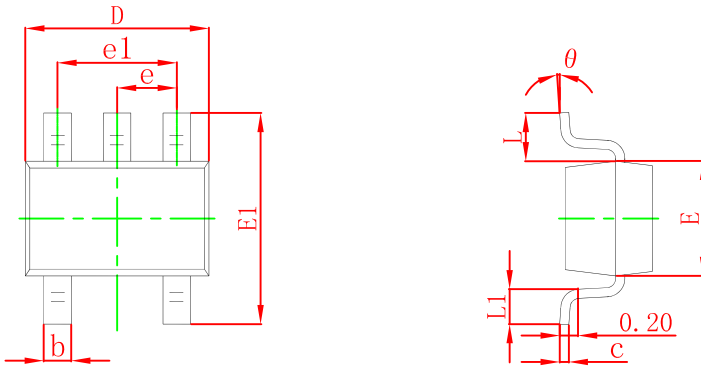

Symbol	Dimensions In Millimeters		Dimensions In Inches	
	Min	Max	Min	Max
A	0.900	1.100	0.035	0.043
A1	0.000	0.100	0.000	0.004
A2	0.900	1.000	0.035	0.039
b	0.150	0.350	0.006	0.014
c	0.100	0.150	0.004	0.006
D	2.000	2.200	0.079	0.087
E	1.150	1.350	0.045	0.053
E1	2.150	2.400	0.085	0.094
e	0.650 TYP		0.026 TYP	
e1	1.200	1.400	0.047	0.055
L	0.525 REF		0.021 REF	
L1	0.260	0.460	0.010	0.018
θ	0°	8°	0°	8°

## SOT-353 Suggested Pad Layout

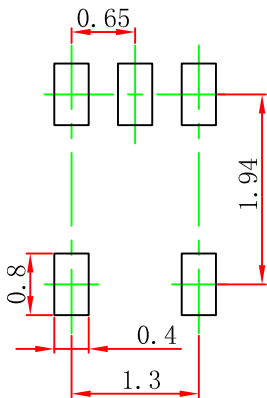

Note:

1. Controlling dimension: in millimeters.
2. General tolerance:  $\pm 0.05$  mm.
3. The pad layout is for reference purposes only.

# SOT-353 Tape and Reel

## SOT-353 Embossed Carrier Tape

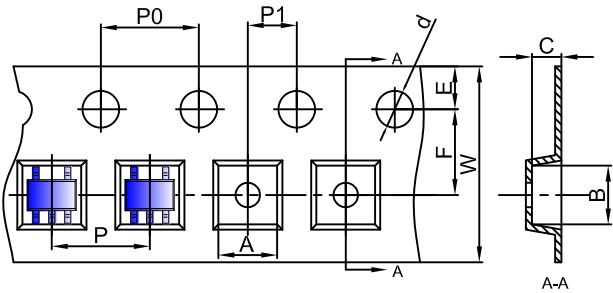

### Packaging Description:

SOT-353 parts are shipped in tape. The carrier tape is made from a dissipative (carbon filled) polycarbonate resin. The cover tape is a multilayer film (Heat Activated Adhesive in nature) primarily composed of polyester film, adhesive layer, sealant, and anti-static sprayed agent. These reeled parts in standard option are shipped with 3,000 units per 7" or 17.8cm diameter reel. The reels are clear in color and is made of polystyrene plastic (anti-static coated).

Dimensions are in millimeter										
Pkg type	A	B	C	d	E	F	P0	P	P1	W
SOT-353	2.25	2.55	1.20	Ø1.50	1.75	3.50	4.00	4.00	2.00	8.00

## SOT-353 Tape Leader and Trailer

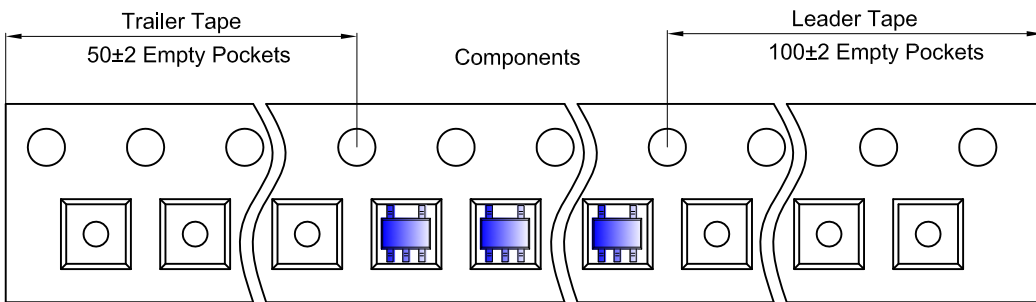

## SOT-353 Reel

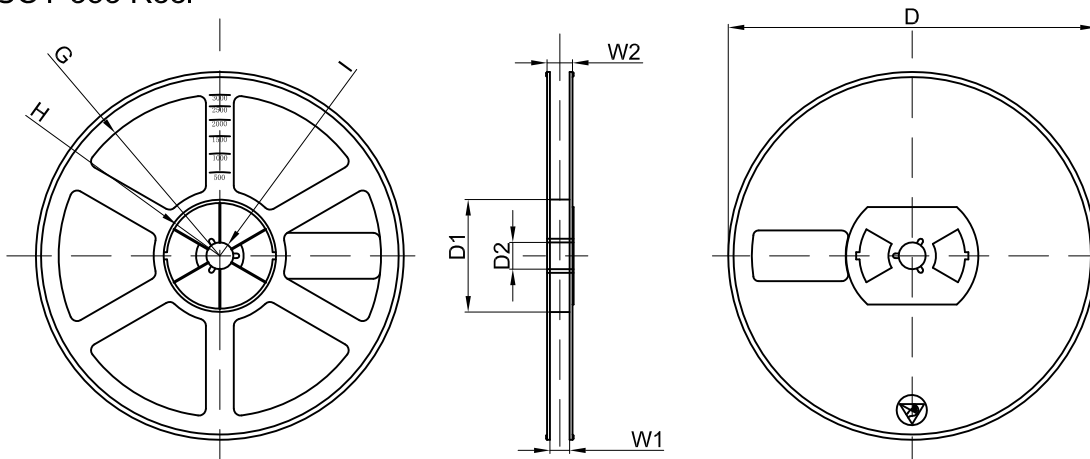

Dimensions are in millimeter								
Reel Option	D	D1	D2	G	H	I	W1	W2
7" Dia	Ø178.00	54.40	13.00	R78.00	R25.60	R6.50	9.50	12.30

REEL	Reel Size	Box	Box Size(mm)	Carton	Carton Size(mm)	G.W.(kg)
3000 pcs	7 inch	45,000 pcs	203×203×195	180,000 pcs	438×438×220	