

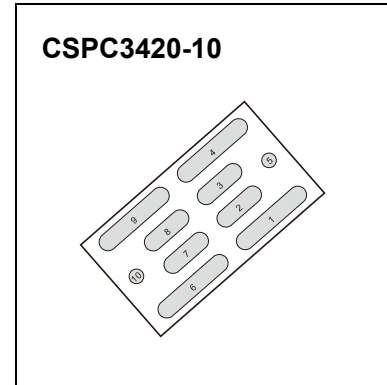

CSP Enhancement Mode Power MOSFET

8618SP Dual N-Channel MOSFET

V _{SSS}	R _{SS(on)} TYP	I _S
23V	3.2mΩ@4.5V	13A
	3.3mΩ@3.8V	
	3.5mΩ@3.1V	
	3.8mΩ@2.5V	



DESCRIPTION

The 8618SP uses advanced trench technology to provide excellent R_{SS(ON)}, low gate charge and operation with gate voltages as low as 2.5V while retaining a 8V V_{GS(MAX)} rating. It is ESD protected. This device is suitable for use as a unidirectional or bi-directional load switch, facilitated by its common-drain configuration.

Marking and pin assignment

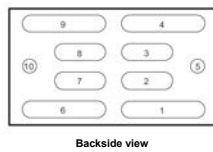

Marking:

- | | |
|-----------------------|--------------------|
| 1. 8618: Product Code | 1, 2, 3, 4 Source1 |
| 2. YYMMX: Date Code | 6, 7, 8, 9 Source2 |
| 3. Solid dot: Pin 1 | 5 Gate1 |
| | 10 Gate2 |

Equivalent Circuit

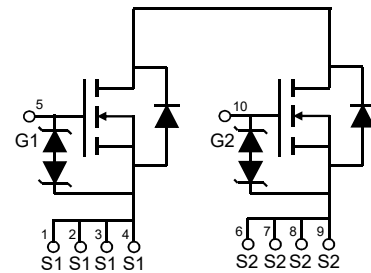

ABSOLUTE MAXIMUM RATINGS (T_a=25°C unless otherwise noted)

Parameter	Symbol	Limit	Unit
Source to Source Voltage	V _{SSS}	23	V
Gate-Source Voltage	V _{GSS}	±8	V
Source Current(DC)	I _S ^①	13	A
Source Current (Pulsed)	I _{SP} ^①	130	A
Total Power Dissipation	P _T ^①	3.1	W
Channel Temperature	T _{ch}	150	°C
Storage Temperature Range	T _{STG}	-55 To 150	°C

MOSFET ELECTRICAL CHARACTERISTICS

$T_a=25\text{ }^\circ\text{C}$ unless otherwise specified

Parameter	Symbol	Condition	Min	Typ	Max	Unit
Static Parameters						
Source to Source Breakdown Voltage	BV_{SSS}	$I_S=1\text{mA}, V_{GS}=0\text{V}$	23			V
Zero-Gate Voltage Source Current	I_{SSS}	$V_{SS}=19\text{V}, V_{GS}=0\text{V}$			100	nA
Gate to Source Leakage Current	I_{GSS}	$V_{SS}=0\text{V}, V_{GS}=\pm 8\text{V}$			± 10	μA
Gate to Source Threshold Voltage	$V_{GS(th)}$	$V_{SS}=V_{GS}, I_S=1.31\text{ mA}$	0.4	0.77	1.4	V
Source to Source On-state Resistance	$R_{SS(on)}$	$V_{GS}=4.5\text{V}, I_S=6.5\text{A}$	0.5	3.2	4.0	$\text{m}\Omega$
		$V_{GS}=3.8\text{V}, I_S=6.5\text{A}$	0.5	3.3	4.2	$\text{m}\Omega$
		$V_{GS}=3.1\text{V}, I_S=6.5\text{A}$	0.5	3.5	4.8	$\text{m}\Omega$
		$V_{GS}=2.5\text{V}, I_S=6.5\text{A}$	0.5	3.8	7.2	$\text{m}\Omega$
Input Capacitance	C_{iss}	$V_{SS}=10\text{V}, V_{GS}=0\text{V}, f=100\text{kHz}$		1010		pF
Output Capacitance	C_{oss}			445		pF
Reverse Transfer Capacitance	C_{rss}			68		pF
Turn-on Delay Time	$t_{d(on)}$	$V_{DD}=10\text{V}, R_L=2.5\Omega, V_{GS}=4.0\text{V}$		0.73		μs
Turn-on Rise Time	t_r			1.73		μs
Turn-off Delay Time	$t_{d(off)}$			9.08		μs
Turn-off Fall Time	t_f			3.36		μs
Total Gate Charge	Q_g	$V_{SS}=10\text{V}, I_S=4\text{A}, V_{GS}=8\text{V}$		69		nC
Gate1-source1 charge	Q_{g1s1}			6.8		nC
Gate1-source2 charge	Q_{g1s2}			10		nC
Diode Forward Voltage	$V_{F(S-S)}$	$V_{GS}=0\text{V}, I_S=6\text{A}$			1.0	V

Notes: 1. Mounted on FR4 board (25.4mm×25.4mm×1.0mm) using the minimum recommended pad size (36um Copper).

2. $t = 10\text{ ms}$, Duty Cycle = 1 %.

3. When FET1 is measured, G2 and S2 are short-circuited.

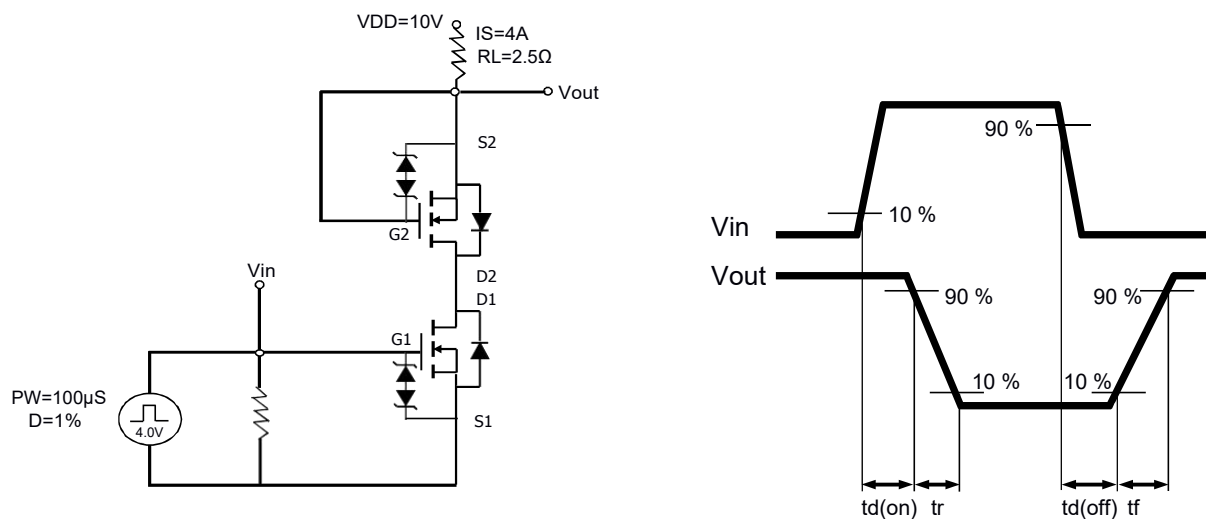

Typical Characteristics

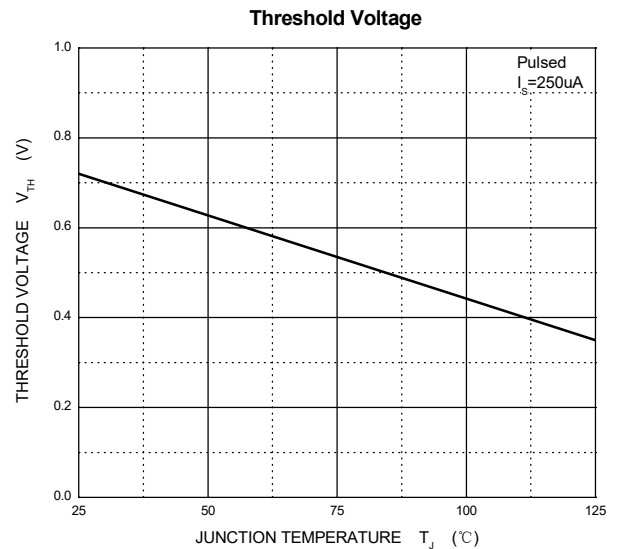
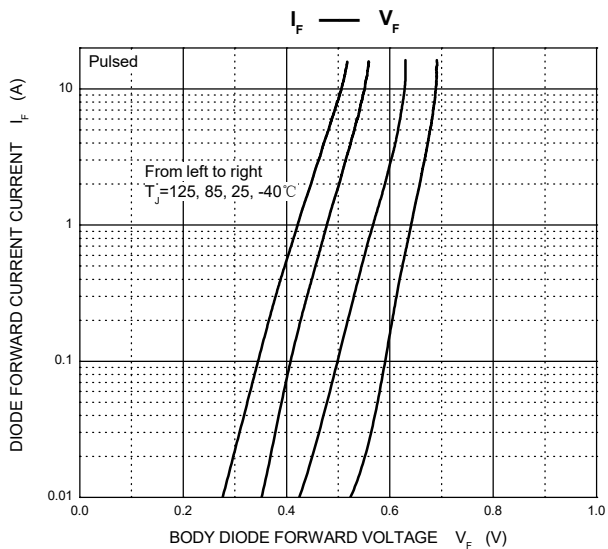
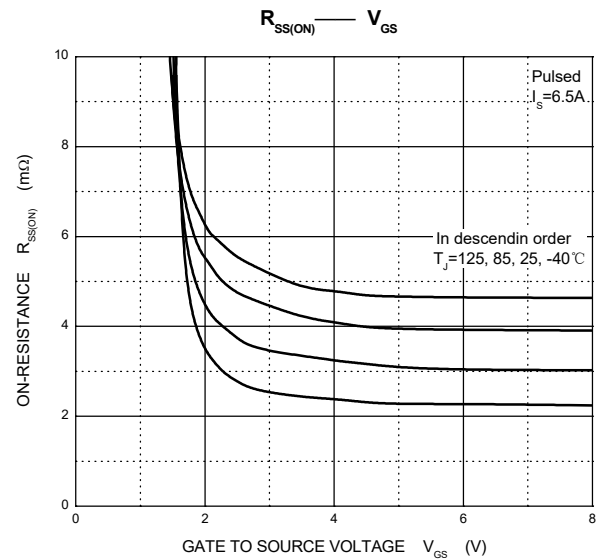
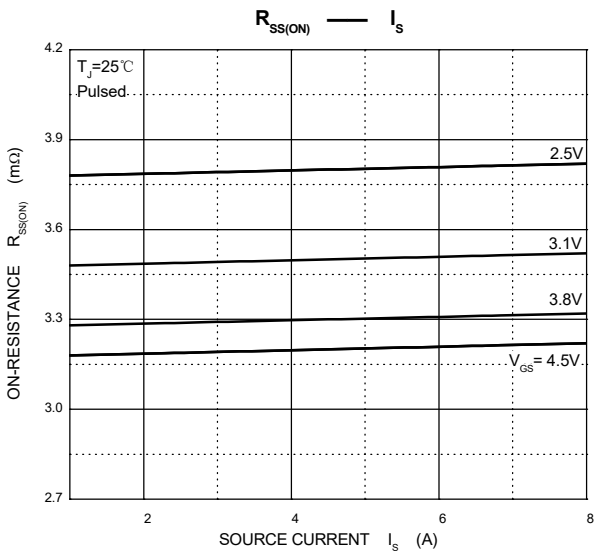
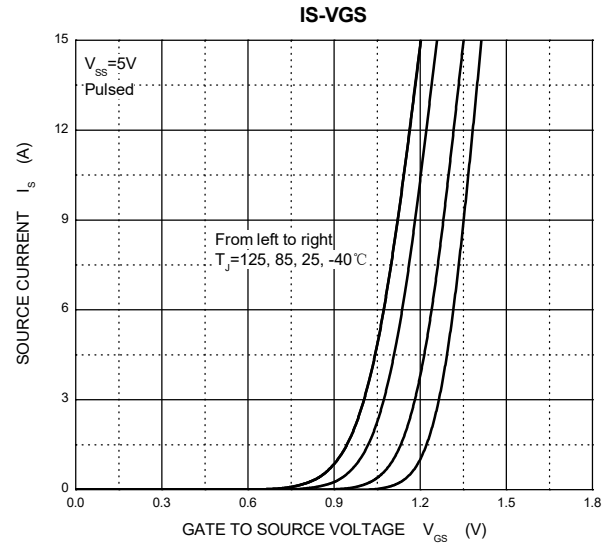
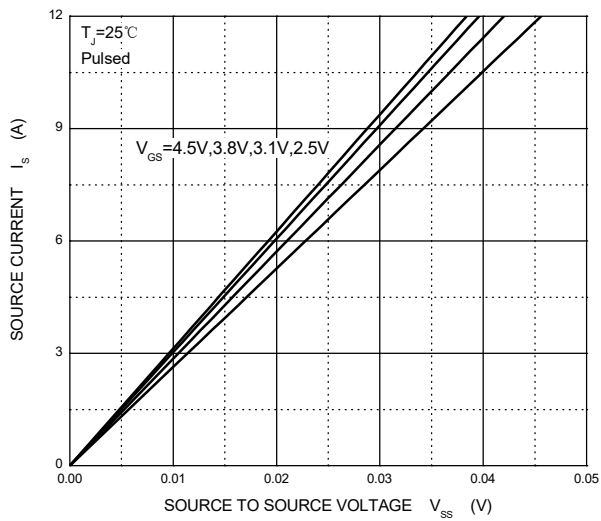

Typical Characteristics

Capacitances

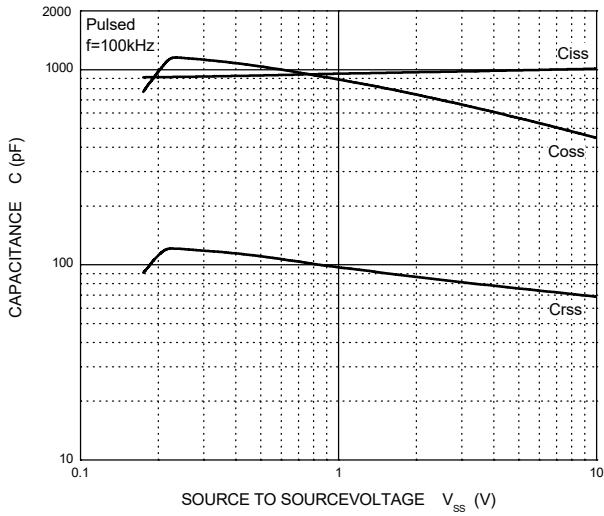

Gate Charge

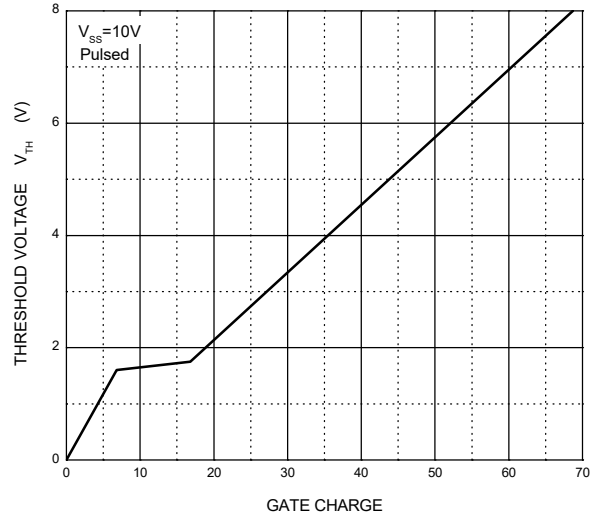

NORMALIZED TRANSIENT THERMAL IMPEDANCE

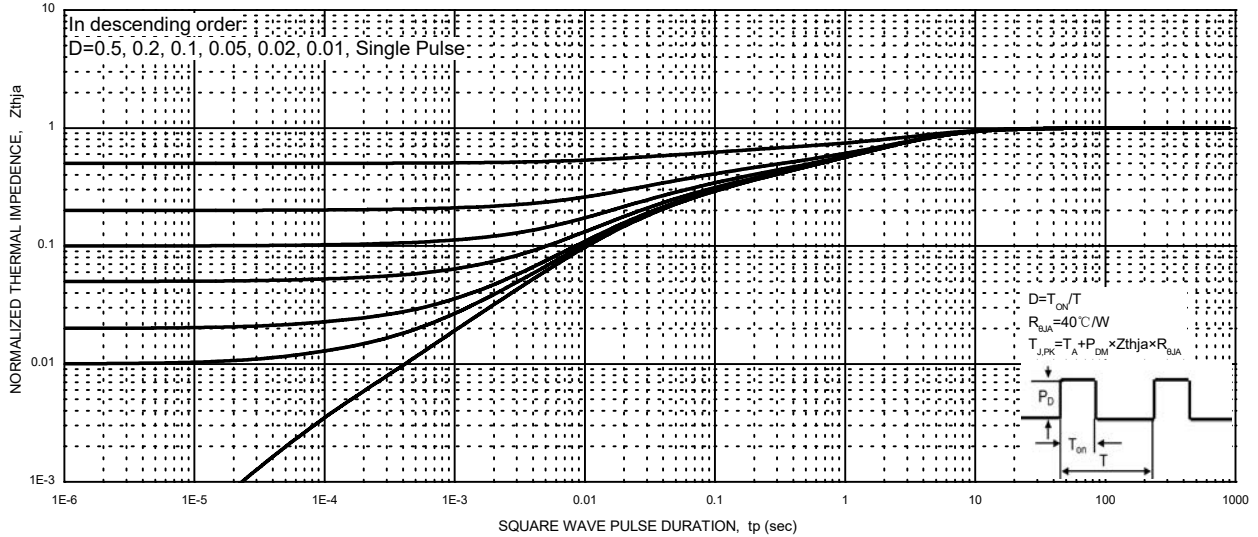

MAXIMUM FORWARD BIASED SAFE OPERATING AREA

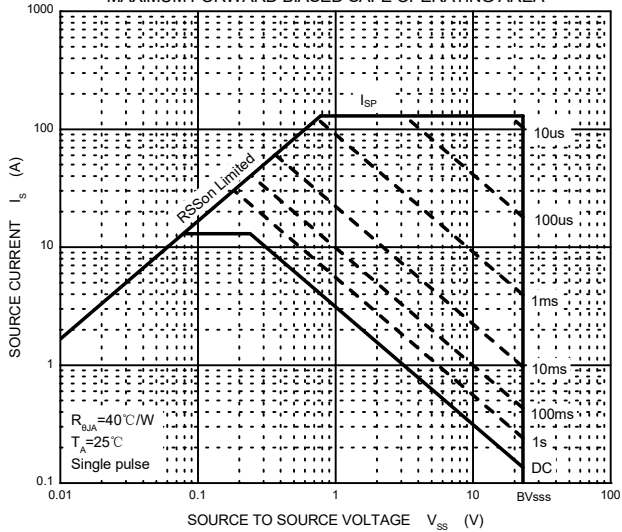

CSPC3420-10 Package Outline Dimensions(Unit:mm)

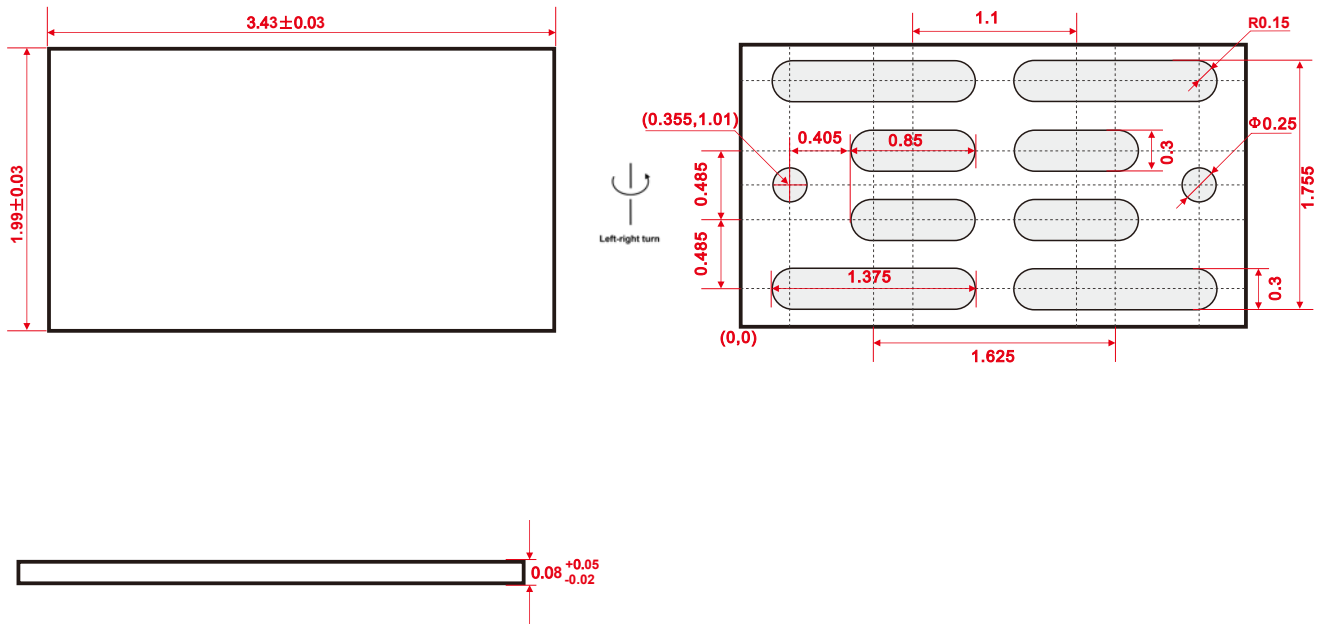

CSPC3420-10 Suggested Pad Layout (Unit:mm)

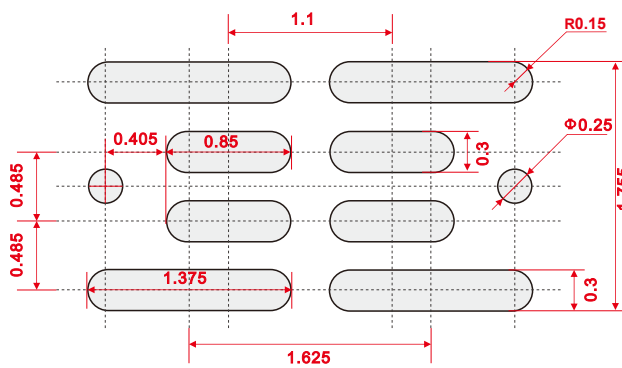

Note:

1. Controlling dimension: in millimeters.
2. General tolerance: ± 0.050 mm.
3. The pad layout is for reference purposes only.

Attention:

- 1、 When exporting the products or technology described in this document, you should comply with the applicable export control laws and regulations and follow the procedures required by such laws and regulations.
- 2、 The products described in this book are intended to be used for general applications (such as office equipment, communications equipment, measuring instruments and household appliances), or for specific applications as expressly stated in this book. Consult our sales staff in advance for information on the following applications: Special applications (such as for airplanes, aerospace, automotive equipment, traffic signaling equipment, combustion equipment, life support systems and safety devices) in which exceptional quality and reliability are required, or if the failure or malfunction of the products may directly jeopardize life or harm the human body. It is to be understood that our company shall not be held responsible for any damage incurred as a result of or in connection with your using the products described in this book for any special application, unless our company agrees to your using the products in this book for any special application.
- 3、 Specifications of any and all ZS products described or contained herein stipulate the performance, characteristics, and functions of the described products in the independent state, and are not guarantees of the performance, characteristics, and functions of the described products as mounted in the customer's products or equipment. To verify symptoms and states that cannot be evaluated in an independent device, the customer should always evaluate and test devices mounted in the customer's products or equipment.
- 4、 You should use the ZS products described in this document within the range specified by ZS especially with respect to the maximum rating, operating supply voltage range, movement power voltage range, heat radiation characteristics, installation and other product characteristics. ZS shall have no liability for malfunctions or damages arising out of the use of ZS products beyond such specified ranges.
- 5、 Regarding monolithic semiconductors, if you should intend to use this IC continuously under high temperature, high current, high voltage, or drastic temperature change, even if it is used within the range of absolute maximum ratings or operating conditions, there is a possibility of decrease reliability. Please contact us for a confirmation.
- 6、 ZS strives to supply high-quality high-reliability products. However, any and all semiconductor products fail with some probability. It is possible that these probabilistic failures could give rise to accidents or events that could endanger human lives, that could give rise to smoke or fire, or that could cause damage to other property. When designing equipment, adopt safety measures so that these kinds of accidents or events cannot occur. Such measures include but are not limited to protective circuits and error prevention circuits for safe design, redundant design, and structural design.
- 7、 No part of this publication may be reproduced or transmitted in any form or by any means, electronic or mechanical, including photocopying and recording, or any information storage or retrieval system, or otherwise, without the prior written permission of CHANGJING ELEC.TECH.
- 8、 ZS has used reasonable care in preparing the information included in this document, but ZS does not warrant that such information is error free. ZS assumes no liability whatsoever for any damages incurred by you resulting from errors in or omissions from the information included herein.
- 9、 The products and product specifications described in this book are subject to change without notice for modification and/or improvement. At the final stage of your design, purchasing, or use of the products, therefore, ask for the most up-to-date Product Standards in advance to make sure that the latest specifications satisfy your requirements.

This catalog provides information as of Dec.2021. Specifications and information herein are subject to change without notice.